



# SGM2019

## Low Power, Low Dropout, RF-Linear Regulators

### GENERAL DESCRIPTION

The SGM2019 series low-power, low-noise, low-dropout, CMOS linear voltage regulators operate from a 2.5V to 5.5V input voltage. They are the perfect choice for low voltage, low power applications. A low ground current makes this part attractive for battery operated power systems. The SGM2019 series also offer ultra low dropout voltage to prolong battery life in portable electronics. Systems requiring a quiet voltage source, such as RF applications, will benefit from the SGM2019 series' ultra low output noise ( $30\mu\text{V}_{\text{RMS}}$ ) and high PSRR. An external noise bypass capacitor connected to the device's BP pin can further reduce the noise level.

The output voltage is preset to voltages in the range of 1.2V to 5.0V. Other features include a 10nA logic-controlled shutdown mode, foldback current limit and thermal shutdown protection.

The SGM2019 is available in Green SOT-23-5 and SC70-5 packages. It operates over an ambient temperature range of  $-40^{\circ}\text{C}$  to  $+85^{\circ}\text{C}$ .

### APPLICATIONS

- Cellular Telephones
- Cordless Telephones
- PCMCIA Cards
- Modems
- MP3 Player
- Hand-Held Instruments
- Palmtop Computers
- Electronic Planners
- Portable/Battery-Powered Equipment

### FEATURES

- Low Output Noise
- Low Dropout Voltage
- Thermal-Overload Protection
- Output Current Limit
- High PSRR (74dB at 1kHz)
- 10nA Logic-Controlled Shutdown
- Available in Multiple Output Voltage Versions
- Fixed Outputs of 1.2V, 1.5V, 1.8V, 2.5V, 2.6V, 2.8V, 2.85V, 3.0V and 3.3V
- Adjustable Output from 1.2V to 5.0V
- $-40^{\circ}\text{C}$  to  $+85^{\circ}\text{C}$  Operating Temperature Range
- Available in Green SC70-5 and SOT-23-5 Packages

### PRODUCT NAME STRUCTURE

SGM2019 - X X X G / TR

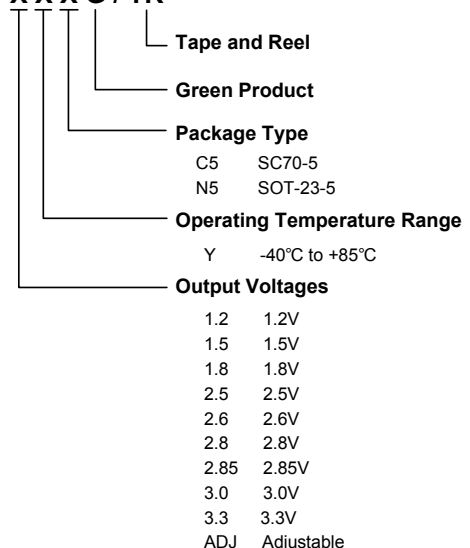

**PIN CONFIGURATIONS (TOP VIEW)**

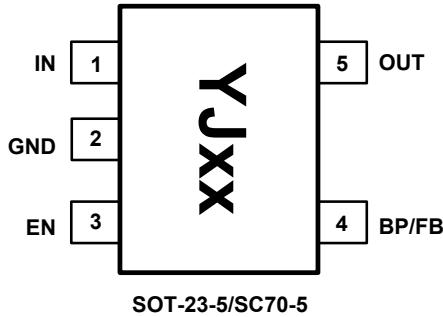

**NOTES:**

1. The location of pin 1 on the YJxx is determined by orienting the package marking as shown.
2. "xx" is the output voltage code. (For Example: when the output voltage is 1.8V, it is expressed as 18.)

**CAUTION**

This integrated circuit can be damaged by ESD if you don't pay attention to ESD protection. SGMICRO recommends that all integrated circuits be handled with appropriate precautions. Failure to observe proper handling and installation procedures can cause damage. ESD damage can range from subtle performance degradation to complete device failure. Precision integrated circuits may be more susceptible to damage because very small parametric changes could cause the device not to meet its published specifications. SGMICRO reserves the right to make any change in circuit design, specification or other related things if necessary without notice at any time. Please contact SGMICRO sales office to get the latest datasheet.

**PIN DESCRIPTION**

PIN	NAME	FUNCTION
<b>SC70-5/SOT-23-5</b>		
1	IN	Regulator Input. Supply voltage can range from 2.5V to 5.5V. Bypass with a 1µF capacitor to GND.
2	GND	Ground.
3	EN	Shutdown Input. A logic low reduces the supply current to 10nA. Connect to IN for normal operation.
4	BP	Reference-Noise Bypass (fixed voltage version only). Bypass with a low-leakage 0.01µF ceramic capacitor for reduced noise at the output.
	FB	Adjustable Voltage Version Only. This is used to set the output voltage of the device.
5	OUT	Regulator Output.

**ABSOLUTE MAXIMUM RATINGS**

IN to GND.....	-0.3V to 6V
Output Short-Circuit Duration .....	Infinite
EN to GND.....	-0.3V to V <sub>IN</sub>
OUT, BP/FB to GND.....	-0.3V to (V <sub>IN</sub> + 0.3V)
Power Dissipation, P <sub>D</sub> @ T <sub>A</sub> = 25°C	
SOT-23-5.....	0.4W
SC70-5 .....	0.3W
Package Thermal Resistance	
SOT-23-5, θ <sub>JA</sub> .....	260°C/W
SC70-5, θ <sub>JA</sub> .....	330°C/W
Operating Temperature Range.....	-40°C to +85°C
Junction Temperature.....	150°C
Storage Temperature Range.....	-65°C to +150°C
Lead Temperature (Soldering, 10s).....	260°C
ESD Susceptibility	
HBM.....	4000V
MM.....	400V

**NOTE:**

Stresses beyond those listed under "Absolute Maximum Ratings" may cause permanent damage to the device. These are stress ratings only, and functional operation of the device at these or any other conditions beyond those indicated in the operational sections of the specifications is not implied. Exposure to absolute maximum rating conditions for extended periods may affect device reliability.

**ELECTRICAL CHARACTERISTICS**(V<sub>IN</sub> = V<sub>OUT (NOMINAL)</sub> + 0.5V<sup>(1)</sup>, Full = -40°C to +85°C, unless otherwise noted.)

PARAMETER	SYMBOL	CONDITIONS	TEMP	MIN	TYP	MAX	UNITS	
Input Voltage	V <sub>IN</sub>		+25°C	2.5		5.5	V	
Output Voltage Accuracy <sup>(1)</sup>		I <sub>OUT</sub> = 0.1mA	+25°C	-2.5		2.5	%	
Maximum Output Current <sup>(1)</sup>		SOT-23-5	+25°C	300			mA	
		V <sub>OUT</sub> = 1.2V, 1.5V, 1.8V, SC70-5		150				
		V <sub>OUT</sub> > 2V, SC70-5		250				
Current Limit <sup>(1)</sup>	I <sub>LIM</sub>		+25°C	310	500		mA	
Ground Pin Current	I <sub>Q</sub>	No load, EN = 2V	+25°C		100	200	μA	
Dropout Voltage <sup>(2)</sup>		I <sub>OUT</sub> = 1mA	+25°C		0.9		mV	
		I <sub>OUT</sub> = 300mA			270	400		
Line Regulation <sup>(1)</sup>	ΔV <sub>LNR</sub>	V <sub>IN</sub> = 2.5V or (V <sub>OUT</sub> + 0.5V) to 5.5V, I <sub>OUT</sub> = 1mA	+25°C		0.02	0.05	%/V	
Load Regulation	ΔV <sub>LDR</sub>	I <sub>OUT</sub> = 0.1mA to 300mA, C <sub>OUT</sub> = 1μF, V <sub>OUT</sub> > 2V	+25°C		0.002	0.005	%/mA	
		I <sub>OUT</sub> = 0.1mA to 300mA, C <sub>OUT</sub> = 1μF, V <sub>OUT</sub> ≤ 2V			0.004	0.008		
Output Voltage Noise	e <sub>n</sub>	f = 10Hz to 100kHz, C <sub>BP</sub> = 0.01μF, C <sub>OUT</sub> = 10μF	+25°C		30		μV <sub>RMS</sub>	
Power Supply Rejection Ratio	PSRR	C <sub>BP</sub> = 0.1μF, I <sub>LOAD</sub> = 50mA, C <sub>OUT</sub> = 1μF, V <sub>IN</sub> = V <sub>OUT</sub> +1V	f = 217Hz	+25°C		77		dB
			f = 1kHz	+25°C		74		dB
<b>SHUTDOWN<sup>(3)</sup></b>								
EN Input Threshold	V <sub>IH</sub>	V <sub>IN</sub> = 2.5V to 5.5V, V <sub>EN</sub> = -0.3V to V <sub>IN</sub>	Full	1.5			V	
	V <sub>IL</sub>		Full			0.3		
EN Input Bias Current	I <sub>B(SHDN)</sub>	EN = 0V or EN = 5.5V	+25°C		0.01	1	μA	
			Full		0.01			
Shutdown Supply Current	I <sub>Q(SHDN)</sub>	EN = 0.4V	Full		0.01		μA	
Shutdown Exit Delay <sup>(4)</sup>		C <sub>BP</sub> = 0.01μF, C <sub>OUT</sub> = 1μF, No Load	+25°C		30		μs	
<b>THERMAL PROTECTION</b>								
Thermal Shutdown Temperature	T <sub>SHDN</sub>				150		°C	
Thermal Shutdown Hysteresis	ΔT <sub>SHDN</sub>				15		°C	

## NOTES:

- V<sub>IN</sub> = V<sub>OUT (NOMINAL)</sub> + 0.5V or 2.5V, whichever is greater.
- The dropout voltage is defined as V<sub>IN</sub> - V<sub>OUT</sub>, when V<sub>OUT</sub> is 100mV below the value of V<sub>OUT</sub> for V<sub>IN</sub> = V<sub>OUT</sub> + 0.5V.  
(Only applicable for V<sub>OUT</sub> = +2.5V to +5.0V.)
- V<sub>EN</sub> = -0.3V to V<sub>IN</sub>
- Time needed for V<sub>OUT</sub> to reach 90% of final value.

TYPICAL APPLICATION CIRCUIT

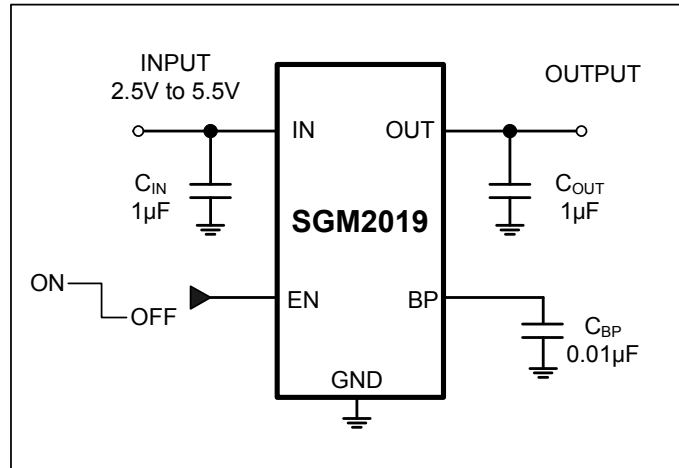

C <sub>BP</sub> (nF)	Shutdown Exit Delay (µs)			PSRR (dB) at 217Hz		
	V <sub>OUT</sub> = 2.8V, V <sub>IN</sub> = 3.3V, EN = 0V to 2V			V <sub>OUT</sub> = 2.8V, V <sub>IN</sub> = V <sub>OUT</sub> + 1V		
	I <sub>LOAD</sub> = 50mA	I <sub>LOAD</sub> = 150mA	I <sub>LOAD</sub> = 300mA	I <sub>LOAD</sub> = 50mA	I <sub>LOAD</sub> = 150mA	I <sub>LOAD</sub> = 300mA
None	21.5	21.5	21	71.1	64.4	55.0
0.001	21.5	21.5	22	71.1	64.6	55.1
0.01	22	22.5	22.5	71.6	64.7	55.2
0.1	22.5	23	23	71.7	64.8	55.4
1	25	27	28.5	72.1	65.2	55.9
10	30	35	39	74.3	68.8	59.6
100	265	280	300	77.0	73.7	63.1

**TYPICAL APPLICATION CIRCUIT**

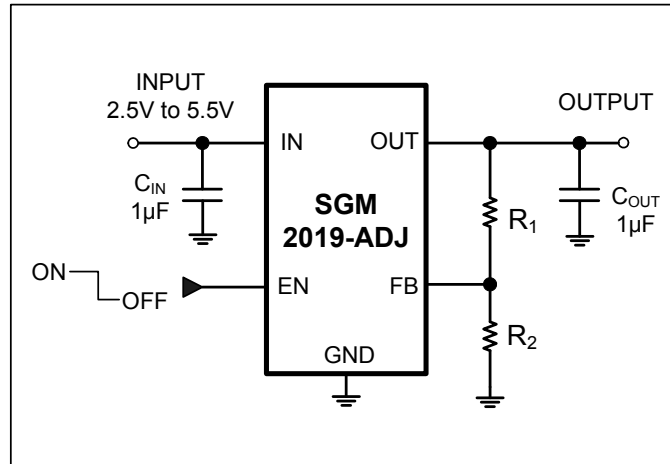

Standard 1% Resistor Values for Common Output Voltages of Adjustable Voltage Version

V <sub>OUT</sub> (V)	R <sub>1</sub> (kΩ)	R <sub>2</sub> (kΩ)
1.2	0	63.4
1.5	10.5	42.2
1.8	34	63.4
2.8	84.5	63.4
3.0	63.4	42.2
3.3	73.2	42.2
3.6	84.5	42.2
4.2	105	42.2

NOTE:  $V_{OUT} = (R_1 + R_2) / R_2 \times 1.207$

TYPICAL PERFORMANCE CHARACTERISTICS

$V_{IN} = V_{OUT(NOMINAL)} + 0.5V$  or  $2.5V$  (whichever is greater),  $C_{IN} = 1\mu F$ ,  $C_{OUT} = 1\mu F$ ,  $C_{BP} = 0.01\mu F$ ,  $T_A = +25^\circ C$ , unless otherwise noted.

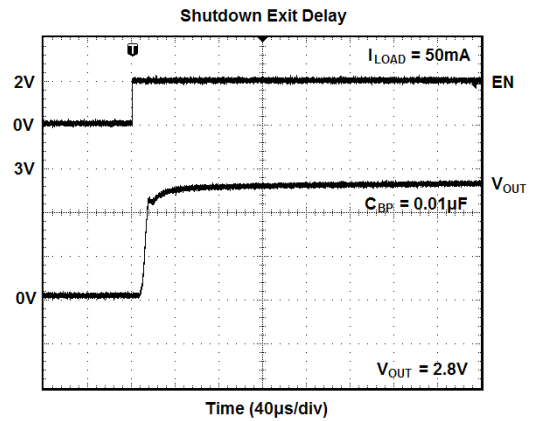
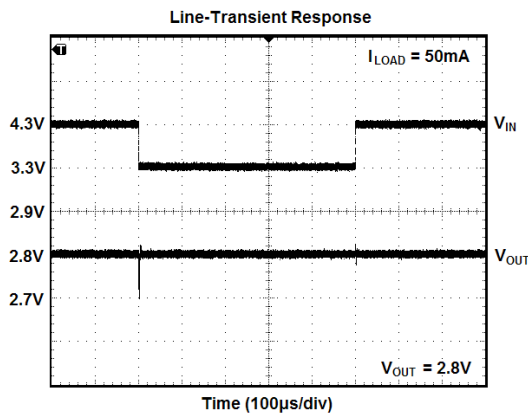
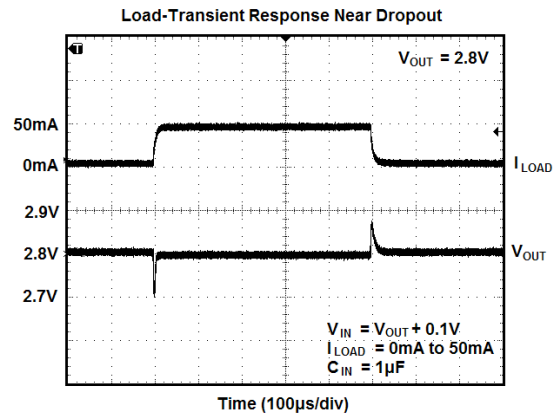
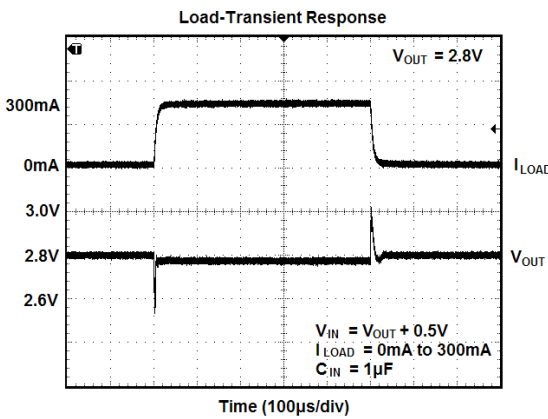
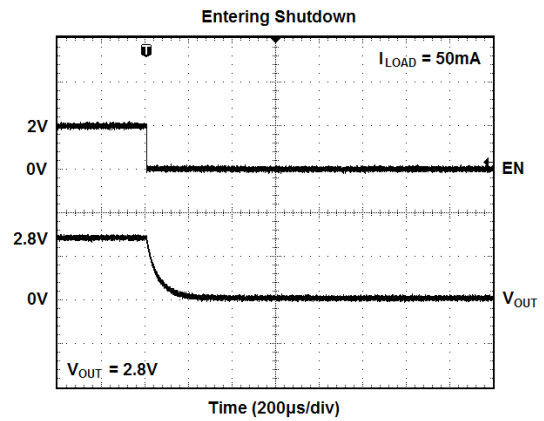
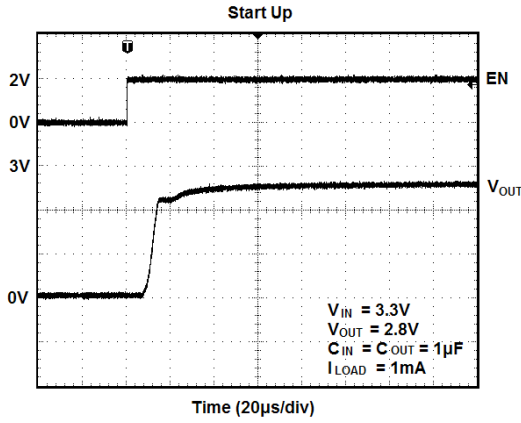

TYPICAL PERFORMANCE CHARACTERISTICS

$V_{IN} = V_{OUT(NOMINAL)} + 0.5V$  or  $2.5V$  (whichever is greater),  $C_{IN} = 1\mu F$ ,  $C_{OUT} = 1\mu F$ ,  $C_{BP} = 0.01\mu F$ ,  $T_A = +25^\circ C$ , unless otherwise noted.

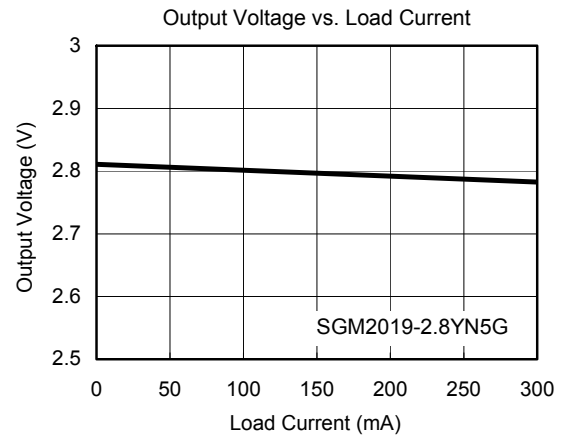
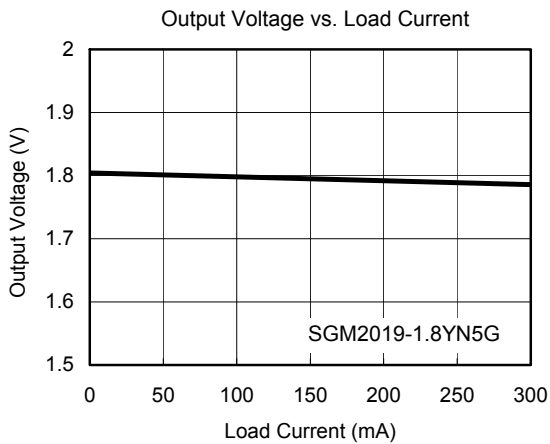
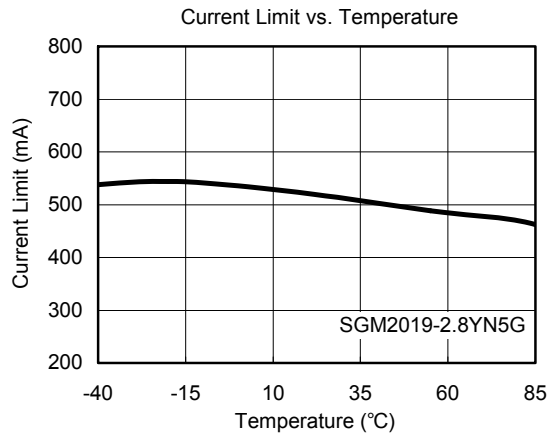
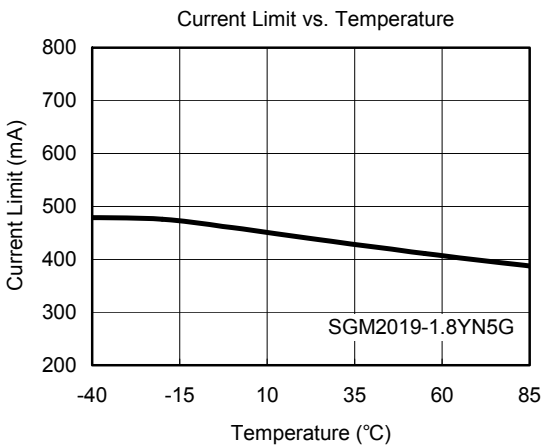
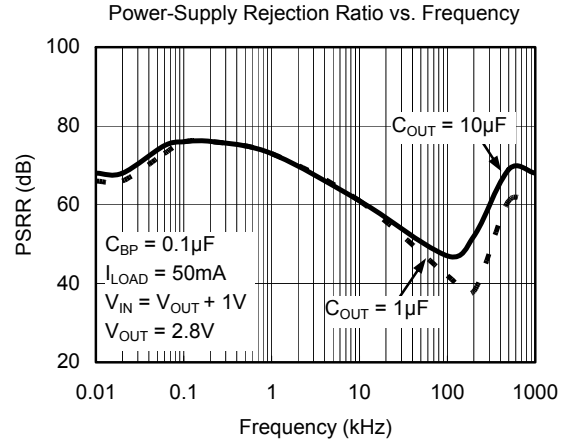
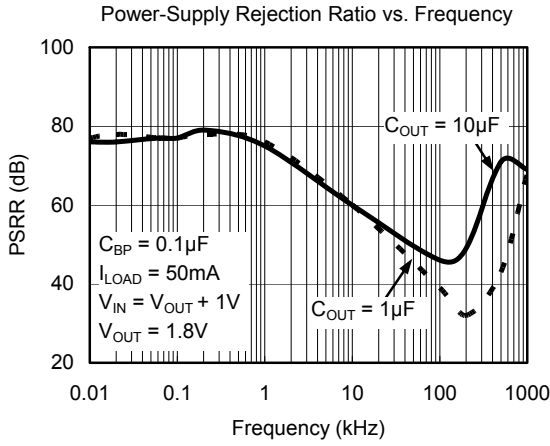

**TYPICAL PERFORMANCE CHARACTERISTICS**

$V_{IN} = V_{OUT(NOMINAL)} + 0.5V$  or  $2.5V$  (whichever is greater),  $C_{IN} = 1\mu F$ ,  $C_{OUT} = 1\mu F$ ,  $C_{BP} = 0.01\mu F$ ,  $T_A = +25^\circ C$ , unless otherwise noted.

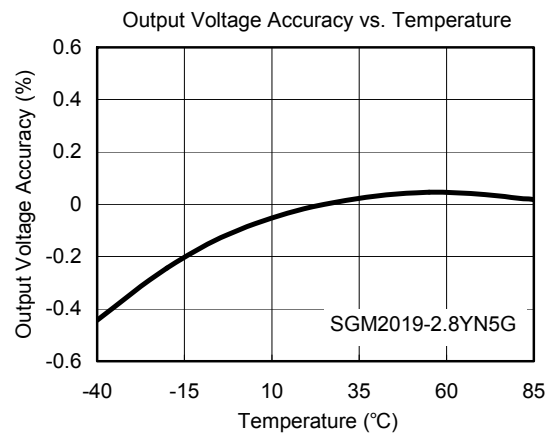
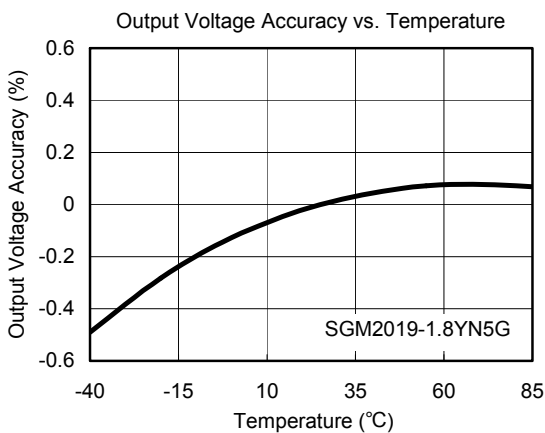
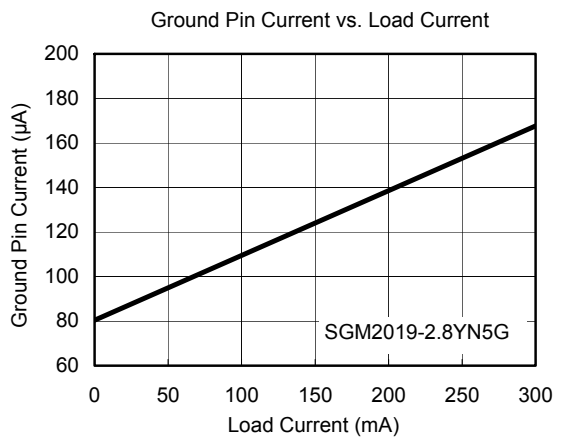
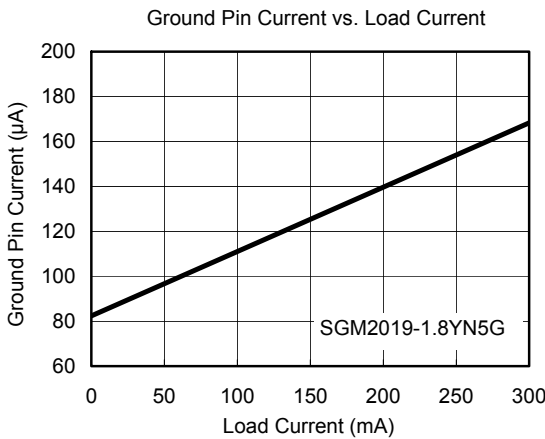
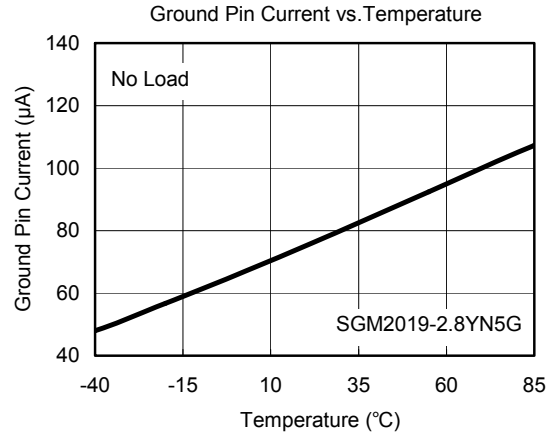
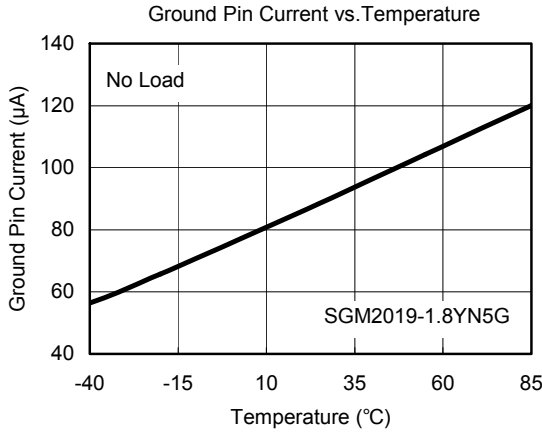



TYPICAL PERFORMANCE CHARACTERISTICS

$V_{IN} = V_{OUT(NOMINAL)} + 0.5V$  or  $2.5V$  (whichever is greater),  $C_{IN} = 1\mu F$ ,  $C_{OUT} = 1\mu F$ ,  $C_{BP} = 0.01\mu F$ ,  $T_A = +25^\circ C$ , unless otherwise noted.

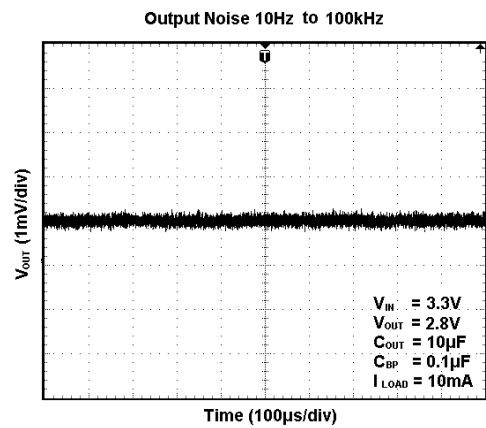
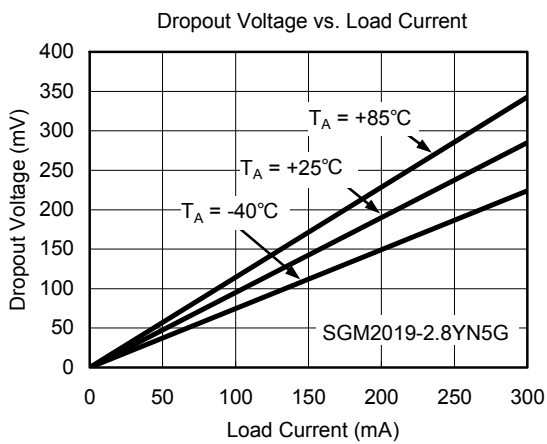
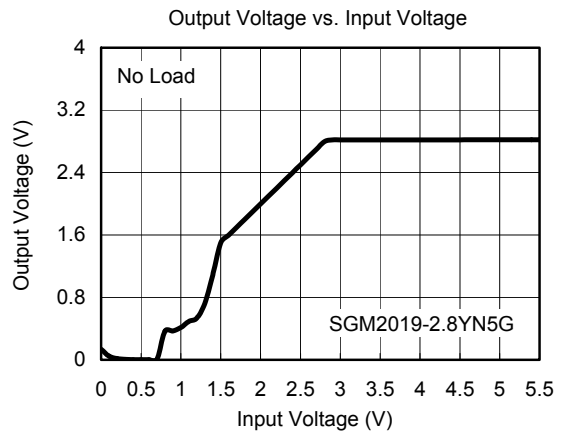
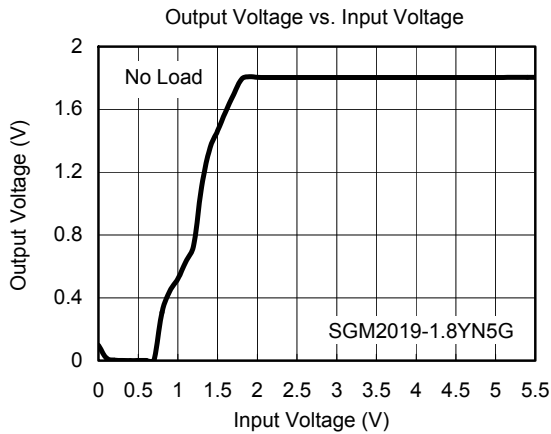
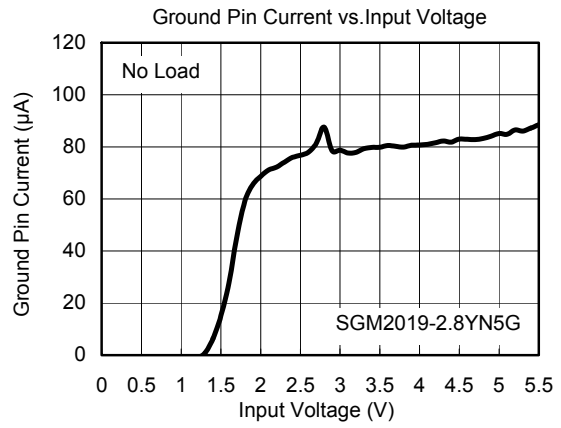
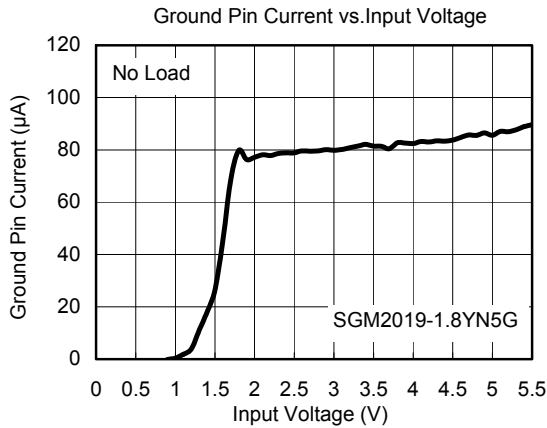

TYPICAL PERFORMANCE CHARACTERISTICS

$V_{IN} = V_{OUT(NOMINAL)} + 0.5V$  or  $2.5V$  (whichever is greater),  $C_{IN} = 1\mu F$ ,  $C_{OUT} = 1\mu F$ ,  $C_{BP} = 0.01\mu F$ ,  $T_A = +25^\circ C$ , unless otherwise noted.

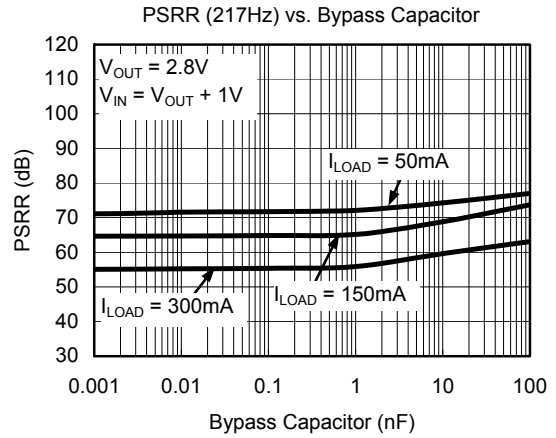
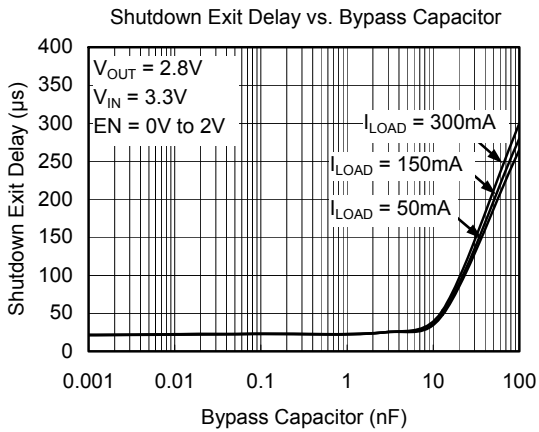

APPLICATION NOTE

When LDO is used in handheld products, attention must be paid to voltage spikes which could damage SGM2019. In such applications, voltage spikes will be generated at charger interface and  $V_{BUS}$  pin of USB interface when charger adapters and USB equipments are hot-plugged. Besides this, handheld products will be tested on the production line without battery. Test engineer will apply power from the connector pin which connects with positive pole of the battery. When external power supply is turned on suddenly, the voltage spikes will be generated at the battery connector. The voltage spikes will be very high, and it always exceeds the absolute maximum input voltage (6.0V) of LDO. In order to get robust design, design engineer needs to clear up this voltage spike. Zener diode is a cheap and effective solution to eliminate such voltage spike. For example, BZM55B5V6 is a 5.6V small package Zener diode which can be used to remove voltage spikes in cell phone designs. The schematic is shown below.

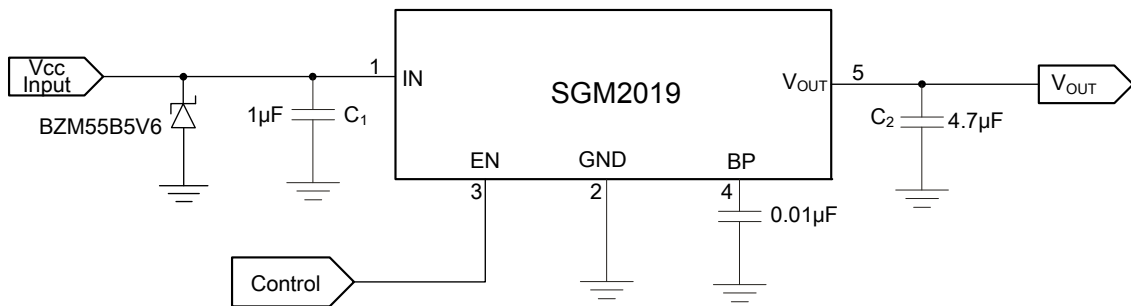

**EXPANDED ORDERING INFORMATION**

MODEL	V <sub>OUT</sub> (V)	PIN-PACKAGE	ORDERING NUMBER	PACKAGE MARKING	PACKAGE OPTION
SGM2019-1.2	1.2V	SOT-23-5	SGM2019-1.2YN5G/TR	YJ12	Tape and Reel, 3000
SGM2019-1.2	1.2V	SC70-5	SGM2019-1.2YC5G/TR	YJ12	Tape and Reel, 3000
SGM2019-1.5	1.5V	SOT-23-5	SGM2019-1.5YN5G/TR	YJ15	Tape and Reel, 3000
SGM2019-1.5	1.5V	SC70-5	SGM2019-1.5YC5G/TR	YJ15	Tape and Reel, 3000
SGM2019-1.8	1.8V	SOT-23-5	SGM2019-1.8YN5G/TR	YJ18	Tape and Reel, 3000
SGM2019-1.8	1.8V	SC70-5	SGM2019-1.8YC5G/TR	YJ18	Tape and Reel, 3000
SGM2019-2.5	2.5V	SOT-23-5	SGM2019-2.5YN5G/TR	YJ25	Tape and Reel, 3000
SGM2019-2.5	2.5V	SC70-5	SGM2019-2.5YC5G/TR	YJ25	Tape and Reel, 3000
SGM2019-2.6	2.6V	SOT-23-5	SGM2019-2.6YN5G/TR	YJ26	Tape and Reel, 3000
SGM2019-2.6	2.6V	SC70-5	SGM2019-2.6YC5G/TR	YJ26	Tape and Reel, 3000
SGM2019-2.8	2.8V	SOT-23-5	SGM2019-2.8YN5G/TR	YJ28	Tape and Reel, 3000
SGM2019-2.8	2.8V	SC70-5	SGM2019-2.8YC5G/TR	YJ28	Tape and Reel, 3000
SGM2019-2.85	2.85V	SOT-23-5	SGM2019-2.85YN5G/TR	YJ2J	Tape and Reel, 3000
SGM2019-2.85	2.85V	SC70-5	SGM2019-2.85YC5G/TR	YJ2J	Tape and Reel, 3000
SGM2019-3.0	3.0V	SOT-23-5	SGM2019-3.0YN5G/TR	YJ30	Tape and Reel, 3000
SGM2019-3.0	3.0V	SC70-5	SGM2019-3.0YC5G/TR	YJ30	Tape and Reel, 3000
SGM2019-3.3	3.3V	SOT-23-5	SGM2019-3.3YN5G/TR	YJ33	Tape and Reel, 3000
SGM2019-3.3	3.3V	SC70-5	SGM2019-3.3YC5G/TR	YJ33	Tape and Reel, 3000
SGM2019-ADJ	adjustable	SOT-23-5	SGM2019-ADJYN5G/TR	YJAA	Tape and Reel, 3000
SGM2019-ADJ	adjustable	SC70-5	SGM2019-ADJYC5G/TR	YJAA	Tape and Reel, 3000

PACKAGE OUTLINE DIMENSIONS

SC70-5

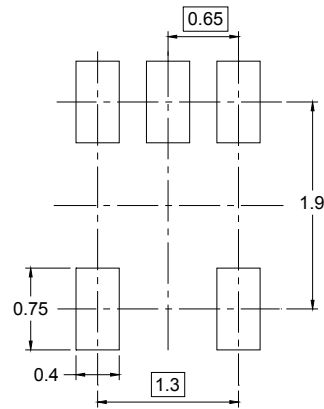
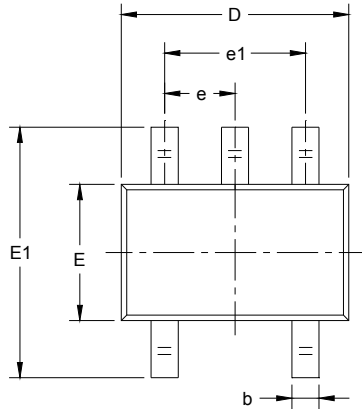

RECOMMENDED LAND PATTERN (Unit: mm)

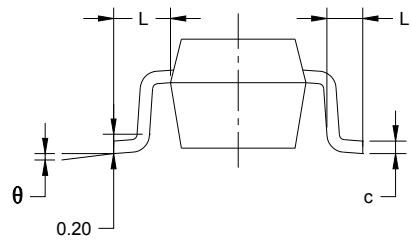
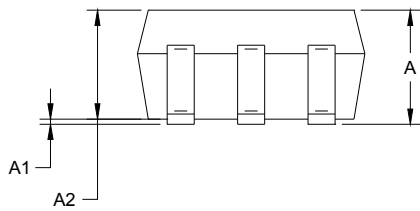

Symbol	Dimensions In Millimeters		Dimensions In Inches	
	MIN	MAX	MIN	MAX
A	0.900	1.100	0.035	0.043
A1	0.000	0.100	0.000	0.004
A2	0.900	1.000	0.035	0.039
b	0.150	0.350	0.006	0.014
c	0.080	0.150	0.003	0.006
D	2.000	2.200	0.079	0.087
E	1.150	1.350	0.045	0.053
E1	2.150	2.450	0.085	0.096
e	0.65 TYP		0.026 TYP	
e1	1.300 BSC		0.051 BSC	
L	0.525 REF		0.021 REF	
L1	0.260	0.460	0.010	0.018
$\theta$	0°	8°	0°	8°

PACKAGE OUTLINE DIMENSIONS

SOT-23-5

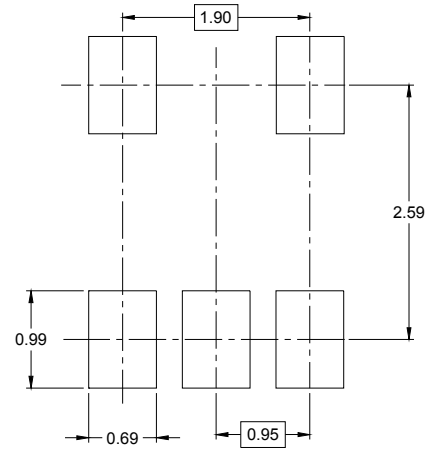
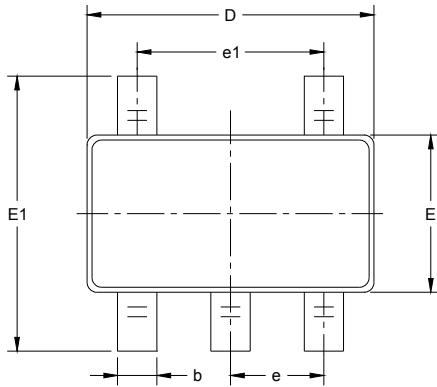

RECOMMENDED LAND PATTERN (Unit: mm)

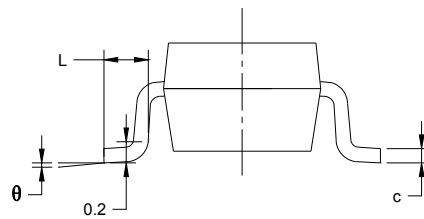
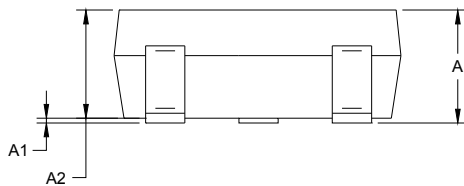

Symbol	Dimensions In Millimeters		Dimensions In Inches	
	MIN	MAX	MIN	MAX
A	1.050	1.250	0.041	0.049
A1	0.000	0.100	0.000	0.004
A2	1.050	1.150	0.041	0.045
b	0.300	0.500	0.012	0.020
c	0.100	0.200	0.004	0.008
D	2.820	3.020	0.111	0.119
E	1.500	1.700	0.059	0.067
E1	2.650	2.950	0.104	0.116
e	0.950 BSC		0.037 BSC	
e1	1.900 BSC		0.075 BSC	
L	0.300	0.600	0.012	0.024
theta	0°	8°	0°	8°

**TAPE AND REEL INFORMATION**

**REEL DIMENSIONS**

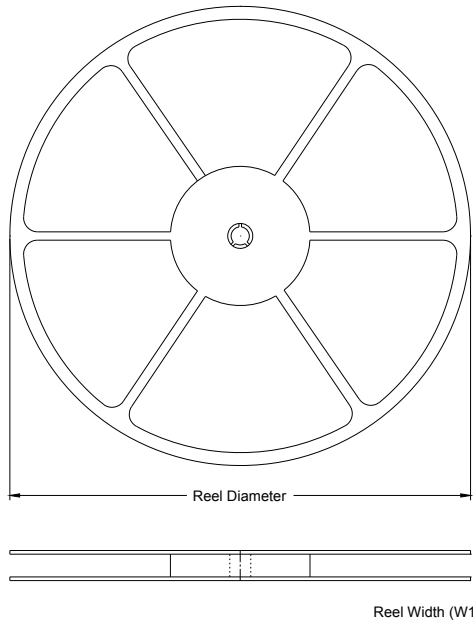

**TAPE DIMENSIONS**

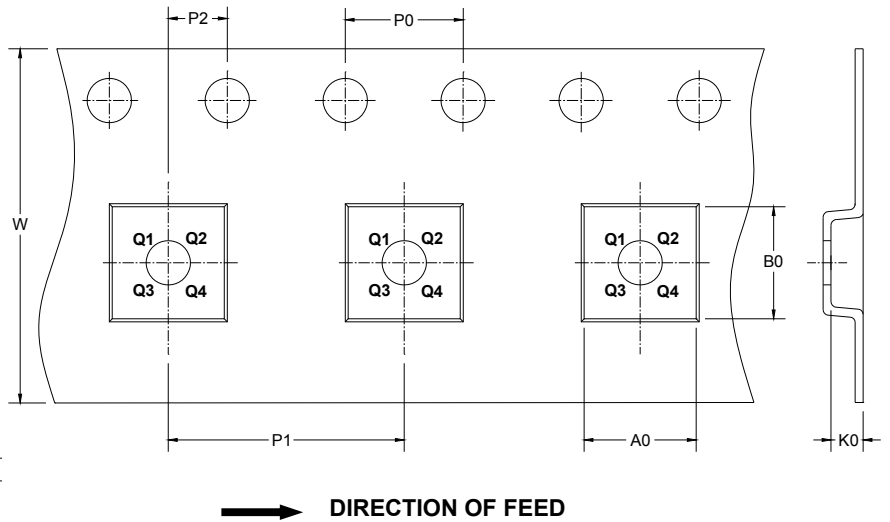

NOTE: The picture is only for reference. Please make the object as the standard.

**KEY PARAMETER LIST OF TAPE AND REEL**

Package Type	Reel Diameter	Reel Width W1 (mm)	A0 (mm)	B0 (mm)	K0 (mm)	P0 (mm)	P1 (mm)	P2 (mm)	W (mm)	Pin1 Quadrant
SC70-5	7"	9.5	2.25	2.55	1.20	4.0	4.0	2.0	8.0	Q3
SOT-23-5	7"	9.5	3.2	3.2	1.4	4.0	4.0	2.0	8.0	Q3

**CARTON BOX DIMENSIONS**

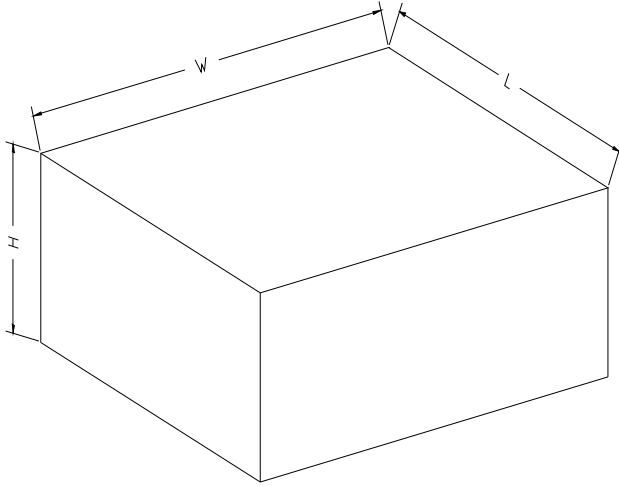

NOTE: The picture is only for reference. Please make the object as the standard.

**KEY PARAMETER LIST OF CARTON BOX**

Reel Type	Length (mm)	Width (mm)	Height (mm)	Pizza/Carton
7" (Option)	368	227	224	8
7"	442	410	224	18