

PWM/PFM Automatic Switching Controlled Synchronous DC-DC Converters

General Description

The LN2402 is a constant frequency, current mode step-down converter. It is ideal for powering portable equipment that runs from a single cell lithium-Ion (Li+) battery. Switching frequency is internally set at 1.5MHz, allowing the use of small surface mount inductor and capacitors. Automatic PWM/PFM mode operation increases efficiency and decreases output voltage ripple at light loads, further extending battery life.

Features

- High Efficiency: 96%
- 1.5MHz Constant Switching Frequency
- Output Current: 1A
- Shutdown Current: <1uA
- Short Circuit Protection

Applications

- Cellular and Smart Phones
- PDAs
- Digital Still and Video Cameras
- Microprocessors and DSP Core Supplies
- Portable Instruments

Package

- SOT-23-5L

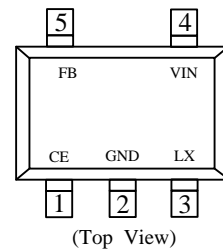

Typical Application Circuit

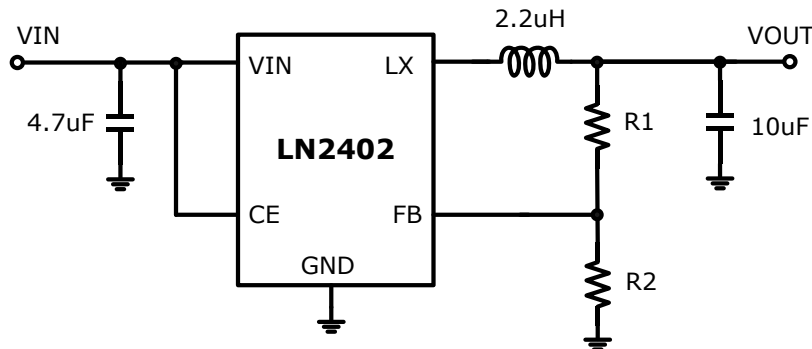

Functional Pin Description

Pin Number	Pin Name	Function
1	CE	Enable control input. Drive CE above 1.2V to turn on the part. Drive CE below 0.6V to turn it off.
2	GND	Ground
3	LX	Power Switch Output. It is the Switch node connection to Inductor.
4	VIN	Supply Input Pin. Must be closely decoupled to GND with a 4.7 μ F or greater ceramic capacitor.
5	FB	Feedback Input Pin. Connect FB to the center point of the external resistor divider. The feedback threshold voltage is 0.6V.

Ordering Information

LN2402A①②

Designator	Symbol	Description
①	D	Automatic PWM/PFM mode
②	J	Embossed Tape : Standard Feed

Marking Rule

- SOT-23-5L

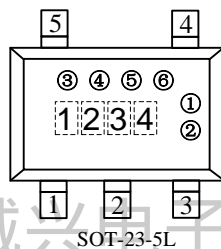

- 1 Represents the product name

Symbol	Product Name
A	LN2402A◆◆◆

- 2 Represents the product classification

Symbol	Working mode
1	PWM/PFM

- 3 Represents the package form

Symbol	package
4	SOT23-5L

- 4 Represents production lot no.

0~9, A~Z repeated (G, I, J, O, Q, W excepted)

Note: ①②③④⑤⑥ Represents Quality control ID.

Function Block Diagram

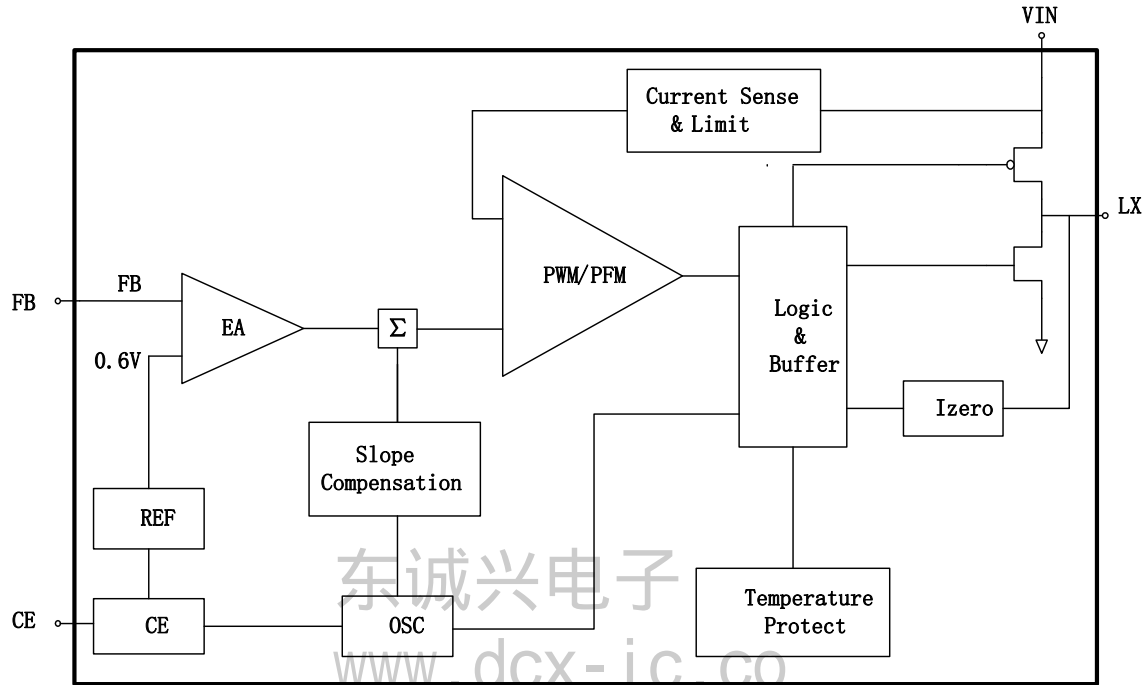

Absolute Maximum Ratings

Parameter		Ratings	Units
Input Supply Voltage		-0.3~7	V
LX Voltage		-0.3~VIN + 0.3	V
CE, FB Voltage		-0.3~VIN + 0.3	V
Peak LX Current		±1600	mA
Power Dissipation	SOT-23-5L	250	mW
Operating Temperature Range		-40~+85	°C
Storage Temperature Range		-55~+125	°C

Note: Absolute Maximum Ratings are those values beyond which the life of a device may be impaired.

Electrical Characteristics

(VIN=CE=3.6V, C1=4.7uF, C2=10uF, L=2.2uH, Ta=25°C, unless otherwise noted)

Parameter	Conditions	MIN	TYP	MAX	Units
Feedback Voltage	Ta=+25°C	0.59	0.6	0.61	V
Input Voltage Range	-	2.5	-	6	V
Output Voltage Load Regulation	ILOAD=10mA to 800mA	-	0.5	-	%
Output Voltage Line Regulation	VIN=2.5 to 5.5V	-	0.06	0.4	%

RDSON of P-CH MOSFET	ILX=100mA	-	0.4	0.5	ohm
RDSON of N-CH MOSFET	ILX=100mA	-	0.35	0.45	ohm
CE "Low" Voltage	VIN=5.0V	-	-	0.9	V
CE "High" Voltage	VIN=5.0V	1.1	-	-	V
Shutdown Current	VIN=5.5V, VCE=0V	0	-	1	uA
Quiescent Current	VFB=0.65V	-	300	500	uA
Output Current	-	1	-	-	A
Short-circuit Current	VIN=3.6V	-	200	-	mA
Peak Inductor Current	VIN=3.6V, VFB=0.5V	1	1.2	1.4	A
LX Leakage	VCE=0V, VIN=5V, VLX=0V	-	±0.01	±1	uA
Oscillation Frequency	VFB=0.6V	1.2	1.5	1.8	MHz
Maximum Duty Circle	-	100	-	-	%
Over Temperature Shutdown	-	-	155	-	°C
Over Temperature Shutdown Hysteresis	-	-	20	-	°C

Typical Performance Characteristics

Output Voltage vs Output Current

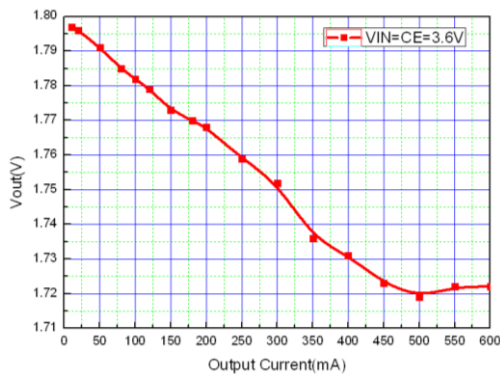

1.2V Efficiency vs Output Current

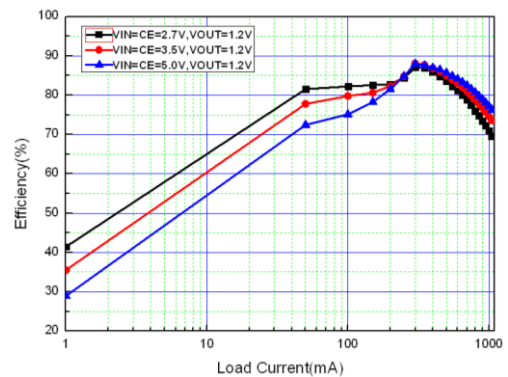

1.8V Efficiency vs Output Current

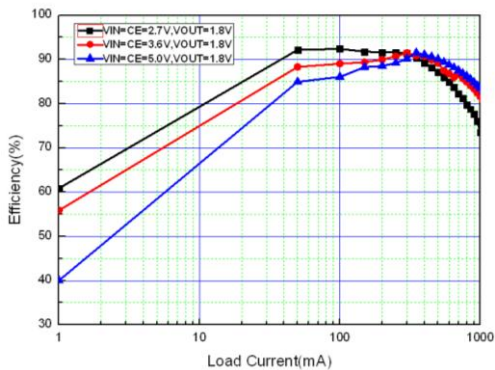

3.3V Efficiency vs Output Current

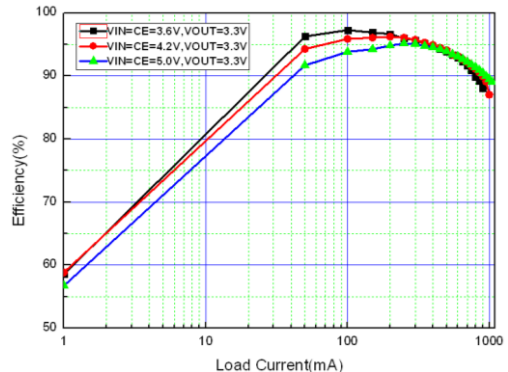

Input Voltage vs Output Voltage

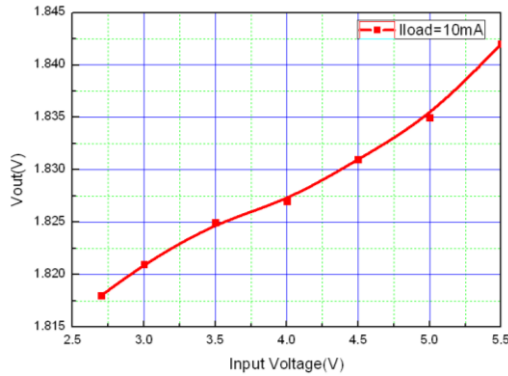

Output Voltage vs Temperature

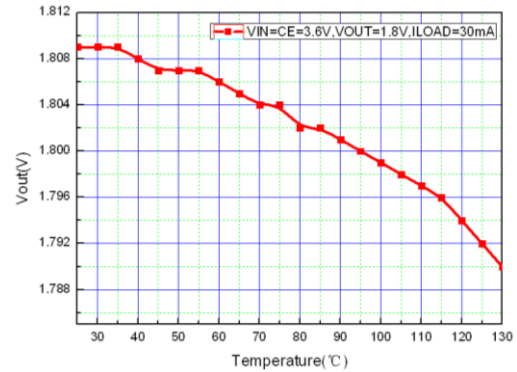

PWM mode VIN=3.6V, ILOAD=600mA

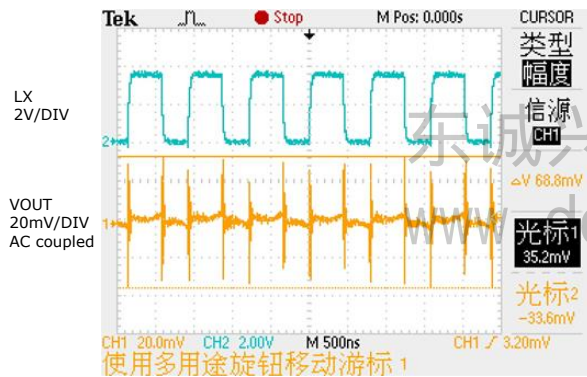

PFM mode VIN=3.6V, ILOAD=50mA

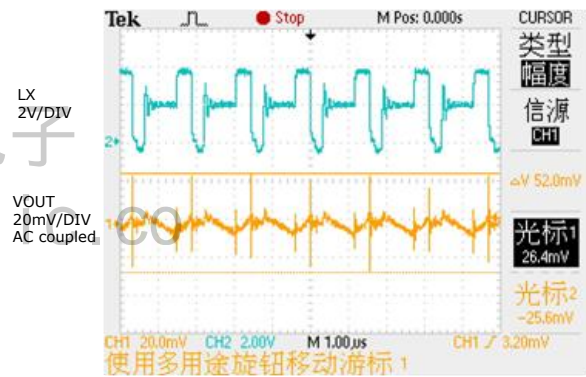

Typical Application

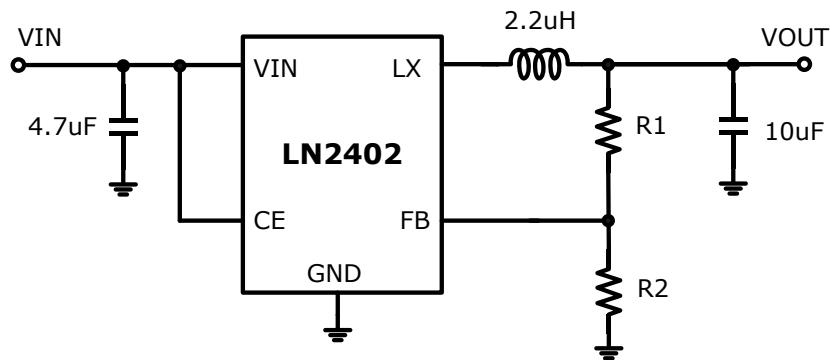

Application Information

LN2402 is a monolithic switching mode Step-Down DC-DC converter. It utilizes internal MOSFETs to achieve high efficiency and can generate very low output voltage by using internal reference at 0.6V. It operates at a fixed switching frequency, and uses the slope compensated current mode architecture. This Step-Down DC-DC Converter supplies 600mA output current at VIN=3V with input voltage range from 2.5V to 6V.

➤ PFM Mode

At light loads, the LN2402 automatically enters PFM Mode. In the PFM Mode, the inductor current may reach zero or reverse on each pulse. The PWM control loop will automatically skip pulses according to the amount of the load current. Therefore, the

oscillation circuit intermittently oscillates, reducing the self-current consumption. This prevents decrease in efficiency when the output load current is small. The ripple voltage during the PFM control is very small, so that the LN2402 realizes high efficiency and the low-noise power supply.

➤ **Setting the Output Voltage**

The output voltage V_{OUT} can be set by using external divider resistors. The internal reference is 0.6V, the V_{OUT} can be calculated by using the following equation:

$$V_{OUT} = \left(1 + \frac{R1}{R2}\right) \times 0.6V$$

Connect divider resistors R1 and R2 as close to the IC as possible to minimize the effects of noise.

➤ **Inductor Selection**

For most designs, the LN2402 operates with inductors of 1.5 μ H to 10 μ H. Low inductance values are physically smaller but require faster switching, which results in some efficiency loss. The inductor value can be derived from the following equation:

$$L = \frac{V_{OUT} \times (V_{IN} - V_{OUT})}{V_{IN} \times \Delta I_L \times f_s}$$

Where f_s is the operation frequency, ΔI_L is inductor Ripple Current. Large value inductors lower ripple current and small value inductors result in high ripple currents. Choose inductor ripple current approximately 40% of the maximum load current for optimum voltage-positioning load transients.

➤ **Input Capacitor Selection**

The input capacitor reduces the surge current drawn from the input and switching noise from the device. The input capacitor impedance at the switching frequency shall be less than input source impedance to prevent high frequency switching current passing to the input. A low ESR input capacitor sized for maximum RMS current must be used. Ceramic capacitors with X5R or X7R dielectrics are highly recommended because of their low ESR and small temperature coefficients. A 4.7 μ F ceramic capacitor for most applications is sufficient.

➤ **Output Capacitor Selection**

The output capacitor is required to keep the output voltage ripple small and to ensure regulation loop stability. The output capacitor must have low impedance at the switching frequency. Ceramic capacitors with X5R or X7R dielectrics are recommended due to their low ESR and high ripple current. A 10 μ F ceramic can satisfy most applications.

■ Package Information

- SOT-23-5L

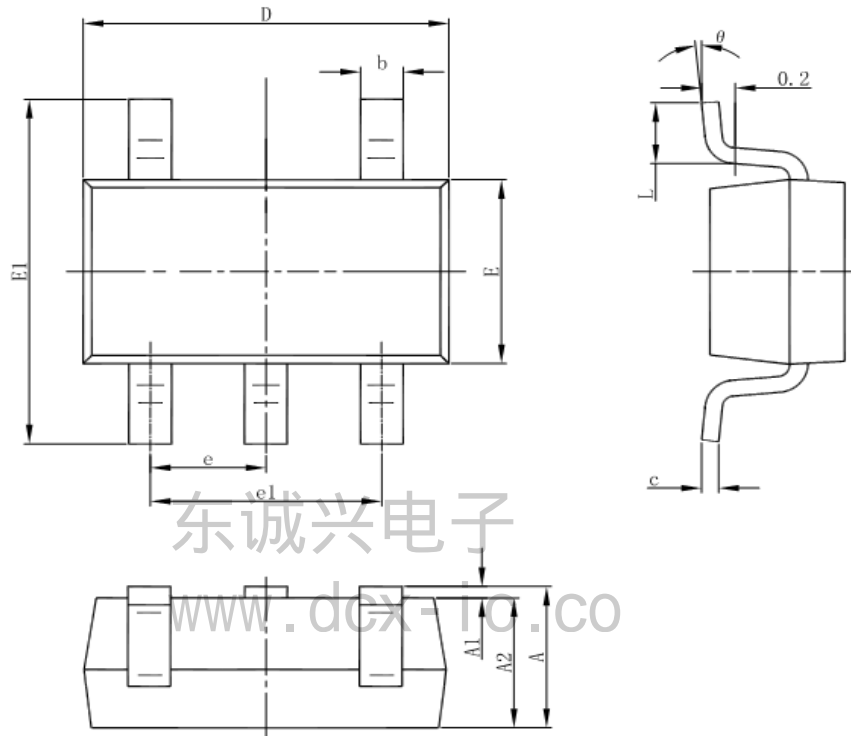

Symbol	Dimensions In Millimeters		Dimensions In Inches	
	Min	Max	Min	Max
A	1.050	1.250	0.041	0.049
A1	0.000	0.100	0.000	0.004
A2	1.050	1.150	0.041	0.045
b	0.300	0.500	0.012	0.020
c	0.100	0.200	0.004	0.008
D	2.820	3.020	0.111	0.119
E	1.500	1.700	0.059	0.067
E1	2.650	2.950	0.104	0.116
e	0.950(BSC)		0.037(BSC)	
e1	1.800	2.000	0.071	0.079
L	0.300	0.600	0.012	0.024
θ	0°	8°	0°	8°